

# Warren Evans

— BEDS & MATTRESSES —

## Assembling your Traditional / Minimalist Warren Evans Bed

### YOUR BED PARTS

Your choice of headboard

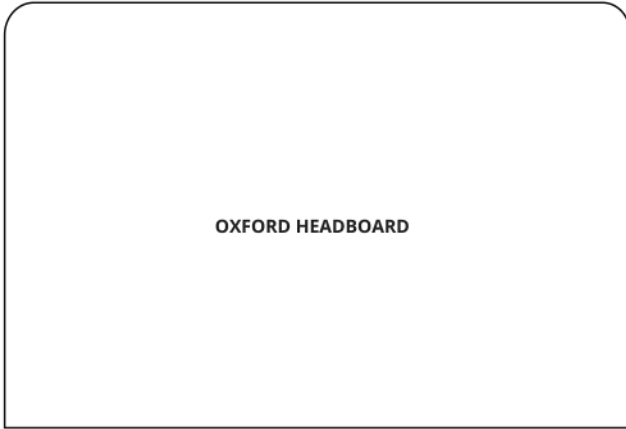

#### SCREW PACK: (SUPPLIED)

- A** 20 x 40mm screws for Slats  
(5'6/6'0 - 20x 60mm screws)
- B** 10 x Pozey flange screws  
(for triangles for headboard)
- C** 6 x 30mm hex screws/bolts (for frame to uprights)
- D** 6 x 20mm hex bolts (for HB to uprights)
- E** 12 x washers
- F** 6 x hexagon dome nuts (for frame to uprights)

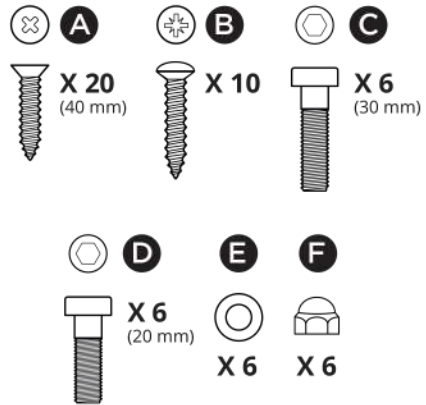

#### BED PARTS:

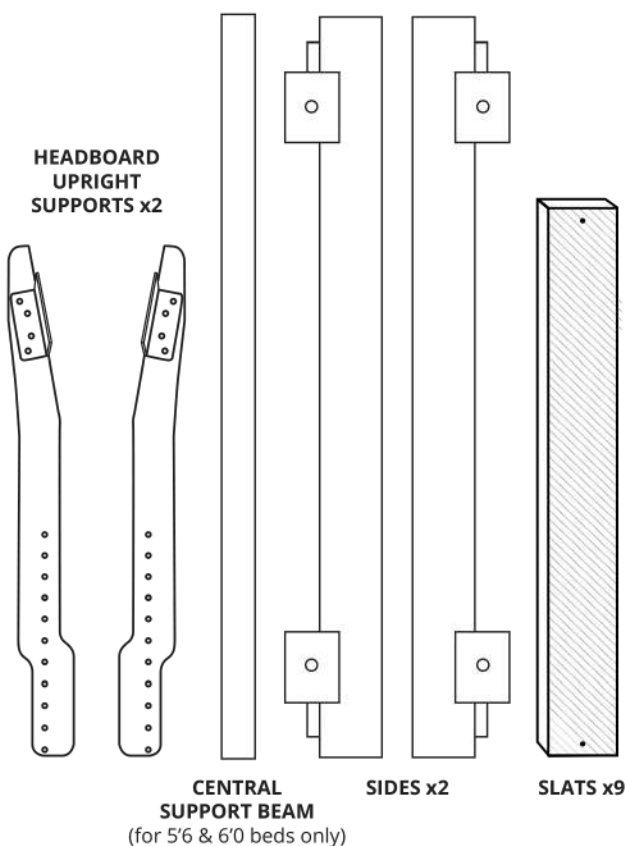

#### TOOLS REQUIRED:

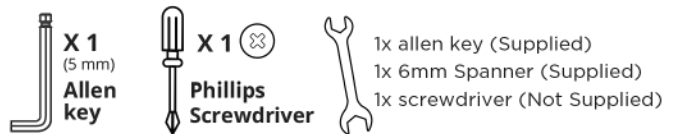

Allen key and Hex bolts are only supplied if you have ordered a headboard

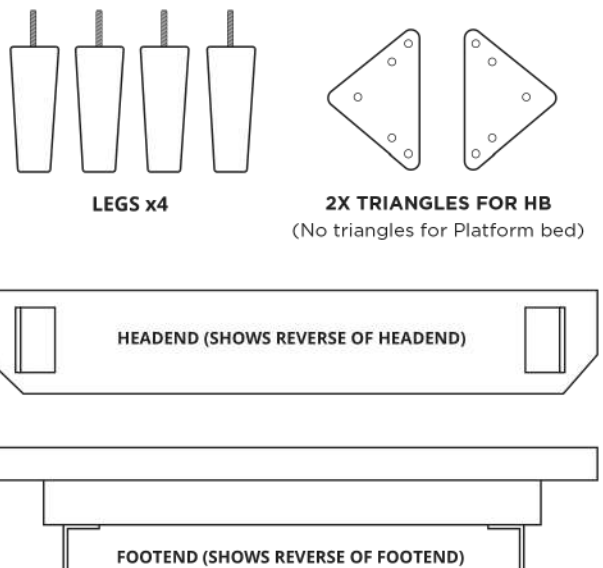

Please contact our sales team on 020 3927 7777 with any problems

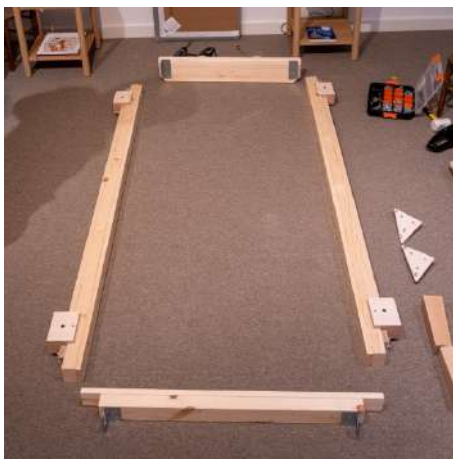

Place Head-end by the wall where you would like the headboard to be.  
Place the sides on the left & right side, and foot end at the bottom.



Screw in all 4 legs.



Flip the sides so that the legs are on the floor.  
Place one side of the foot-end bracket onto the Hex screws.  
*(The bolts are already in place for you)*

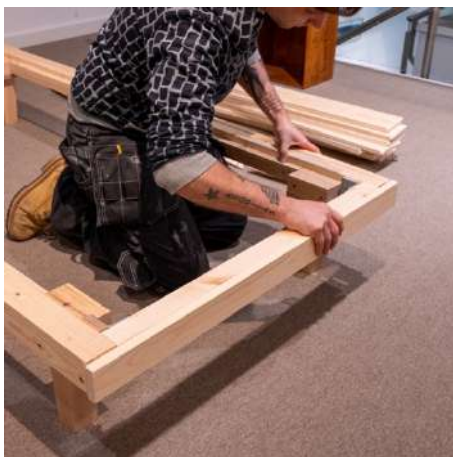

Flip the other side and repeat the same process.



Make sure that the side and foot-end is flush to each other.  
Screw in the hex bolts with the allen key provided to tighten to the metal bracket.  
Making sure its all flush.

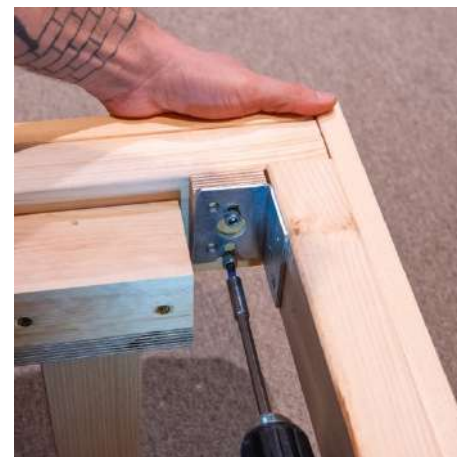

With your other hand make sure that the foot-end and side is flush, whilst screwing the hex bolts down.

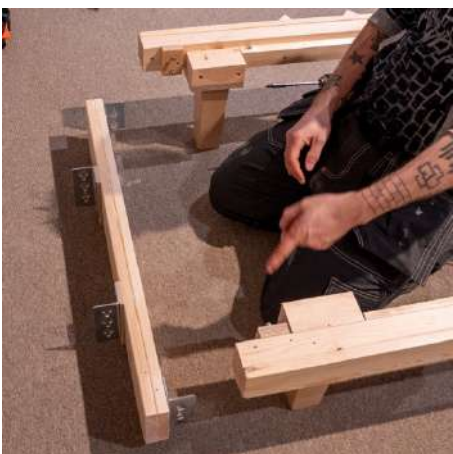

*If you have 5'0 or smaller bed SKIP THIS STEP*

For 5'6 / 6'0 beds, place the central support beam on the metal bracket, do not screw it in.

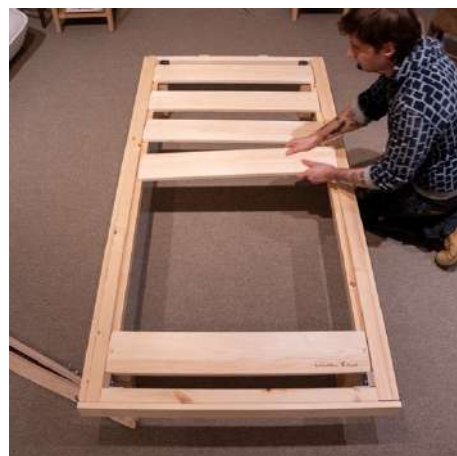

Place all 9 of the slats from top to bottom.

The last slat (Bottom) should be the one with the 'Warren Evans' Logo.



Repeat the same process with the head-end of the bed.





Make sure to push the top slat as far up as it can go, and the bottom slat as far down as it can go. Both top and bottom slats have to touch the exterior frame. Screw in all the slats using the 40mm screws provided.

On the head-end place one of the triangles provided flush to the head end and flush to the side as shown in the picture.

Screw it in place with the pozey flange screws provided.

*If you have a 5'6 / 6'0 bed frame, make sure to screw the top and bottom slat to the center beam.*



Through the side that doesn't have the metal bracket attached. Place 3x washers and 30mm hex bolts provided through the headboard uprights (starting from the 5<sup>th</sup> hole from the bottom).

Place the uprights into the bracket at the back of the head-end. make sure that the metal brackets on the uprights are facing inwards.

First place another 3x washers through the bolt on both sides. Then, use the dome hexagon nuts provided and put all 6 of them on finger tight.

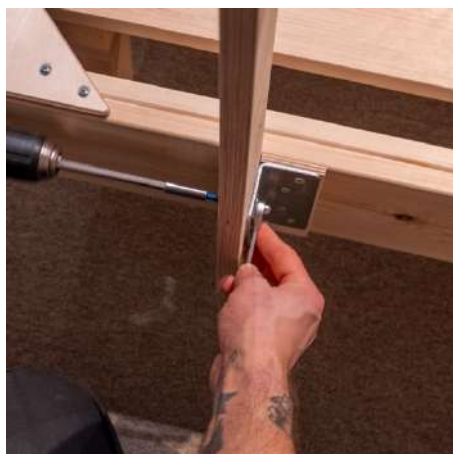

Now using the spanner and allen key provided make sure to tighten the uprights to the bed frame.

Place the 20mm Hex bolts in all 6 holes at the back of the headboard. Only turn the hex bolts a couple times, not all the way.

Place the headboard onto the headboard uprights. Using the allen key provided tighten down the bolts.